

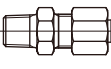

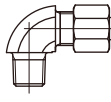

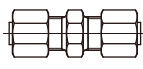

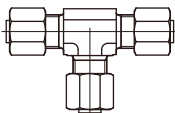
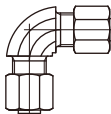
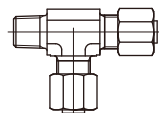
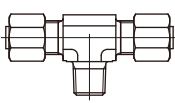
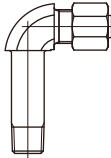

NE bite type tube fittings , OST-2

Name of manufacturer : IHARA SCIENCE CORPORATION

N a m e	Configuration	M o d e l	Applicable pipe O.D. (mm)	Thread size	Mass(kg)	Model of manufacturer
Male Connector		ZH-8FKCT08020	ø8	R1/4	0.046	KCT08-020E
		ZH-8FKCT12030	ø12	R3/8	0.071	KCT12-030E
		ZH-8FKCT12020	ø12	R1/4	0.068	KCT12-020E
Male Elbow		ZH-8FKLN08020	ø8	R1/4	0.065	KLN08-020E
		ZH-8FKLN12030	ø12	R3/8	0.105	KLN12-030E
		ZH-8FKLN12020	ø12	R1/4	0.096	KLN12-020E
Union		ZH-8FKUA08000	ø8	-	0.059	KUA08-000E
		ZH-8FKUA12000	ø12	-	0.093	KUA12-000E
Union Tee		ZH-8FKTA08000	ø8	-	0.122	KTA08-000E
		ZH-8FKTA12000	ø12	-	0.172	KTA12-000E
Union Elbow		ZH-8FKLA08000	ø8	-	0.077	KLA08-000E
		ZH-8FKLA12000	ø12	-	0.124	KLA12-000E
Male Run Tee		ZH-8FKTK08020	ø8	R1/4	0.102	KTK08-020E
		ZH-8FKTK12030	ø12	R3/8	0.143	KTK12-030E
		ZH-8FKTK12020	ø12	R1/4	0.135	KTK12-020E
Male Branch Tee		ZH-8FKTN08020	ø8	R1/4	0.102	KTN08-020E
		ZH-8FKTN12030	ø12	R3/8	0.143	KTN12-030E
		ZH-8FKTN12020	ø12	R1/4	0.135	KTN12-020E
Extended Male Elbow		ZH-8FKLL08020	ø8	R1/4	0.103	KLL08-020E
		ZH-8FKLL12030	ø12	R3/8	0.156	KLL12-030E
		ZH-8FKLL12020	ø12	R1/4	0.156	KLL12-020E

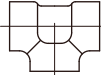
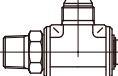

N a m e	Configuration	M o d e l	O.D. (mm)	Thickness (mm)	Length(mm)	Mass(kg)
OST-2		ZH-8FOP081200	ø8	1	2000	0.444
		ZH-8FOP121200	ø12	1.5		0.776

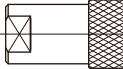
Fittings

Name	Configuration	Model	Thread size	Mass(kg)	Model of manufacturer	Name of manufacturer
High pressure nipple		ZH-8FSNP01000	R1/8	0.013	SNP01-000J	IHARA SCIENCE CORPORATION
		ZH-8FSNP02000	R1/4	0.032	SNP02-000J	
		ZH-8FSNP03000	R3/8	0.048	SNP03-000J	
High pressure reducing nipple		ZH-8FSRN02010	R1/4 - R1/8	0.03	SRN02-01F	
		ZH-8FSRN03020	R3/8 - R1/4	0.045	SRN03-02F	
		ZH-8FSRN04020	R1/2 - R1/4	0.078	SRN04-02F	
High pressure coupling		ZH-8FSFC02000	Rc1/4	0.075	SFC02-000F	
		ZH-8FSFC03000	Rc3/8	0.074	SFC03-000F	
Street elbow		ZH-8FSLC02000	Rc1/4 - R1/4	0.057	SLC02-000J	
		ZH-8FSLC03000	Rc3/8 - R3/8	0.1	SLC03-000J	
90° Elbow		ZH-8FSLA02000	Rc1/4	0.09	SLA02-000F	
		ZH-8FSLA03000	Rc3/8	0.16	SLA03-000F	
Tee		ZH-8FSTA02000	Rc1/4	0.12	STA02-000F	
		ZH-8FSTA03000	Rc3/8	0.21	STA03-000F	
Swivel joint		ZH-9A2422-000	G1/4 - R1/4	0.1	-	
Hollow hex plug		ZH-9A2326-200	R1/4	0.008	GJ1/4-19	Gosho works,ltd
		ZH-9A2326-300	R3/8	0.016	GJ3/8-19	
Hydraulic coupler (Male)		ZH-8FQC02HP00	Rc1/4	0.04	2HP	NITTO KOHKI CO.,LTD.
Hydraulic coupler (Female)		ZH-8FQC02HS00	Rc1/4	0.134	2HS	

One-touch fittings

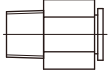
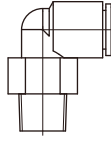
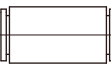
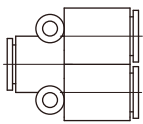
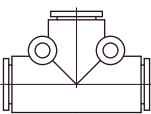
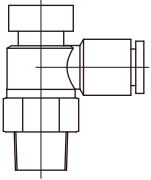
Name of manufacturer : SMC Corporation

Name	Configuration	Model	Applicable tube O.D. (mm)	Thread size	Mass(kg)	Model of manufacturer
Male connector		ZH-9A2443-080	ø6	R1/8	0.006	KQ2H06-01AS
		ZH-9A2443-090	ø6	R1/4	0.013	KQ2H06-02AS
		ZH-9A2443-150	ø10	R1/4	0.022	KQ2H10-02AS
		ZH-9A2443-160	ø10	R3/8	0.023	KQ2H10-03AS
Male elbow		ZH-9A2441-080	ø6	R1/8	0.005	KQ2L06-01AS
		ZH-9A2441-090	ø6	R1/4	0.015	KQ2L06-02AS
		ZH-9A2441-150	ø10	R1/4	0.022	KQ2L10-02AS
		ZH-9A2441-160	ø10	R3/8	0.045	KQ2L10-03AS
Straight union		ZH-9A2443-250	ø6	-	0.002	KQ2H06-00A
		ZH-9A2443-270	ø10	-	0.006	KQ2H10-00A
Union"Y"		ZH-9A2377-020	ø6	-	0.005	KQ2U06-00A
		ZH-9A2377-040	ø10	-	0.011	KQ2U10-00A
Union tee		ZH-9A2369-020	ø6	-	0.004	KQ2T06-00A
		ZH-9A2369-400	ø10	-	0.011	KQ2T10-00A
Speed controllers (Meter-out)		ZH-4PTR939901	ø6	R1/8	0.01	AS2201F-01-06SA
		ZH-4PTR939902	ø6	R1/4	0.018	AS2201F-02-06SA
		ZH-4PTR939903	ø10	R1/4	0.020	AS2201F-02-10SA
		ZH-4PTR939904	ø10	R3/8	0.032	AS3201F-03-10SA
Name	Configuration	Model	O.D. of Applied tube (mm)	Thread size	Mass(kg)	Model of manufacturer
Plug-in reducer		ZH-9A6009-Q3B	ø6	ø10	0.002	KQ2R06-10A

Hose fittings

Name of manufacturer : Nitta Corporation

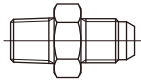
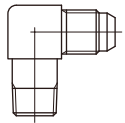
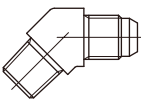
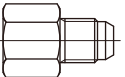
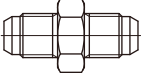
Name	Configuration	Model	Thread size of hose connection	Thread size of port connection	Mass(kg)	Model of manufacturer
Straight		ZH-8FA0100402	G 1/4	R 1/8	0.03	010-04-02
		ZH-8FA0100404	G 1/4	R 1/4	0.035	010-04-04
		ZH-8FA0100406	G 1/4	R 3/8	0.05	010-04-06
		ZH-8FA0100604	G 3/8	R 1/4	0.05	010-06-04
		ZH-8FA0100606	G 3/8	R 3/8	0.055	010-06-06
90° elbow		ZH-8FA0900402	G 1/4	R 1/8	0.045	090-04-02
		ZH-8FA0900404	G 1/4	R 1/4	0.05	090-04-04
		ZH-8FA0900406	G 1/4	R 3/8	0.08	090-04-06
		ZH-8FA0900604	G 3/8	R 1/4	0.075	090-06-04
		ZH-8FA0900606	G 3/8	R 3/8	0.08	090-06-06
45° elbow		ZH-8FA0450402	G 1/4	R 1/8	0.035	045-04-02
		ZH-8FA0450404	G 1/4	R 1/4	0.04	045-04-04
		ZH-8FA0450406	G 1/4	R 3/8	0.06	045-04-06
		ZH-8FA0450604	G 3/8	R 1/4	0.06	045-06-04
		ZH-8FA0450606	G 3/8	R 3/8	0.065	045-06-06
Female-thread straight		ZH-8FA0300404	G 1/4	R c1/4	0.025	030-04-04
		ZH-8FA0300606	G 3/8	R c3/8	0.055	030-06-06
Name	Configuration	Model	Thread size of hose connection	Thread size of port connection	Mass(kg)	Model of manufacturer
Interconnection straight		ZH-8FA1500404	G 1/4		0.05	150-04-04
		ZH-8FA1500606	G 3/8		0.075	150-06-06

Hydraulic hoses

Name of manufacturer : Nitta Corporation

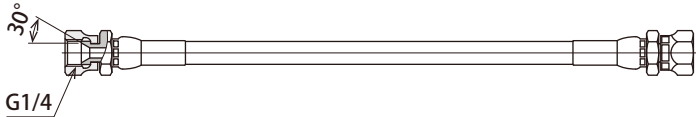
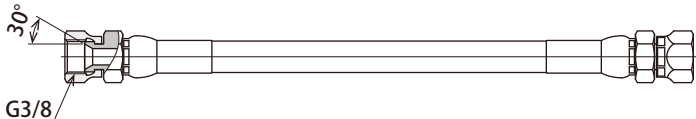
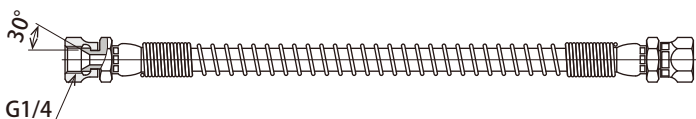
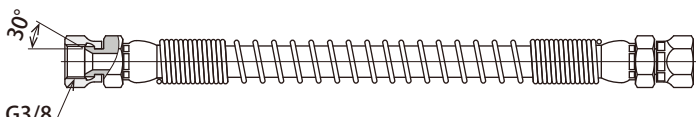
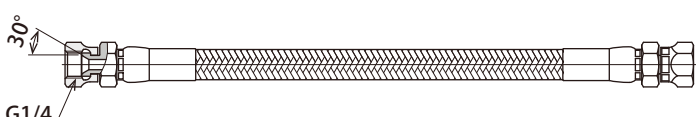
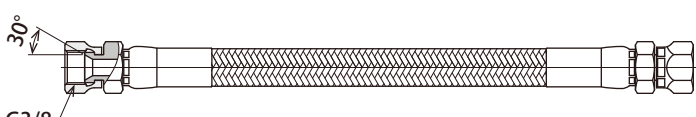
Name	Configuration	Model	Overall length (mm)	Mass(kg)
Standard G1/4	 <p>Swage coupling part No. SE-PF-03 Hose part No. 3000-03</p>	ZH-8FHC030500	500	0.16
		ZH-8FHC030600	600	0.168
		ZH-8FHC030700	700	0.176
		ZH-8FHC030800	800	0.183
		ZH-8FHC030900	900	0.191
		ZH-8FHC031000	1000	0.198
Standard G3/8	 <p>Swage coupling part No. SE-PF-06 Hose part No. 3000-06</p>	ZH-8FHC060500	500	0.264
		ZH-8FHC060600	600	0.278
		ZH-8FHC060700	700	0.292
		ZH-8FHC060800	800	0.306
		ZH-8FHC060900	900	0.32
		ZH-8FHC061000	1000	0.334
Guard spring G1/4	 <p>Swage coupling part No. SE-PF-03 Hose part No. 3000-03</p>	ZH-8FHD030500	500(※)	0.259
		ZH-8FHD030600	600(※)	0.286
		ZH-8FHD030700	700(※)	0.314
		ZH-8FHD030800	800	0.32
		ZH-8FHD030900	900	0.341
		ZH-8FHD031000	1000	0.361
Guard spring G3/8	 <p>Swage coupling part No. SE-PF-06 Hose part No. 3000-06</p>	ZH-8FHD060500	500(※)	0.429
		ZH-8FHD060600	600(※)	0.485
		ZH-8FHD060700	700(※)	0.538
		ZH-8FHD060800	800	0.477
		ZH-8FHD060900	900	0.515
		ZH-8FHD061000	1000	0.542
Wire braid G1/4	 <p>Swage coupling part No. SE-PF-04 Hose part No. 3000-04</p>	ZH-8FHE040500	500	0.27
		ZH-8FHE040600	600	0.292
		ZH-8FHE040700	700	0.314
		ZH-8FHE040800	800	0.336
		ZH-8FHE040900	900	0.358
		ZH-8FHE041000	1000	0.38
Wire braid G3/8	 <p>Swage coupling part No. SE-PF-06 Hose part No. 3000-06</p>	ZH-8FHE060500	500	0.37
		ZH-8FHE060600	600	0.4
		ZH-8FHE060700	700	0.43
		ZH-8FHE060800	800	0.46
		ZH-8FHE060900	900	0.49
		ZH-8FHE061000	1000	0.52

(※) Length exclusively for Pascal

Manifold blocks

Model	Configuration	Thread size	Mass(kg)
W B A 4		4-Rc1/4	0.36
Reference: Mounting screw M6x30 (model:ZH-8BSCM06030) Spring washer M6 (model:ZH-8WS2M06000)			
W B A 6		6-Rc1/4	0.54
Reference: Mounting screw M6x30 (model:ZH-8BSCM06030) Spring washer M6 (model:ZH-8WS2M06000)			
W B A 9		9-Rc1/4	0.575
Reference: Mounting screw M6x30 (model:ZH-8BSCM06030) Spring washer M6 (model:ZH-8WS2M06000)			
W B A 4 - 03 (made to order)		4-Rc3/8	0.845
Reference: Mounting screw M8x35 (model:ZH-8BSCM08035) Spring washer M8 (model:ZH-8WS2M08000)			
W B A 06 - 03 (made to order)		6-Rc3/8	1.165
Reference: Mounting screw M8x35 (model:ZH-8BSCM08035) Spring washer M8 (model:ZH-8WS2M08000)			
W B A 09 - 03 (made to order)		9-Rc3/8	1.24
Reference: Mounting screw M8x35 (model:ZH-8BSCM08035) Spring washer M8 (model:ZH-8WS2M08000)			

Mounting screws are not included. Mounting screw and Spring washer in the above diagram needs to be ordered separately.

Glycerine bath type pressure gauges

Name of manufacturer : YODOGAWAKEIKI

Model	Configuration	Full scale	Application	Colored circle	Mass(kg)	Model of manufacturer
SK-HCS-9A35331414		1MPa	Air pressure gauge	0.45~0.5MPa Green other Red	0.11	IADGT-R2-42x1M-414
SK-HCS-9A35331410		1MPa	Air pressure gauge	N/A	0.11	IADGT-R2-42x1M-410
SK-HCS-9A3533345G		40MPa	Oil pressure gauge	with Safety mark	0.105	IADGU-R2-39x40M-45G

Example of use

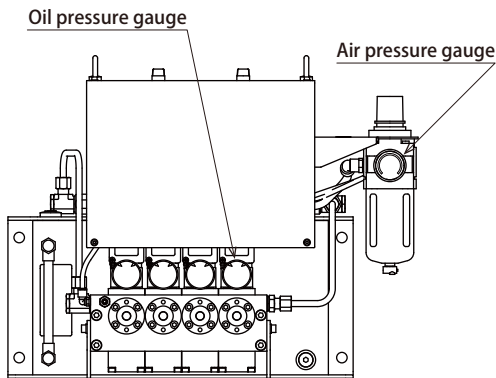

Control unit
HCPD-H22DDDD-U

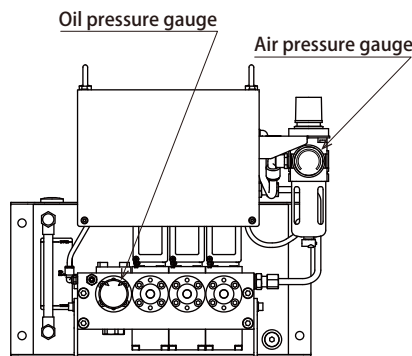

Control unit
HCSD-H2EDDD

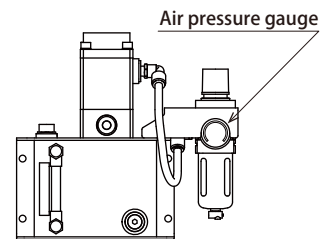

Power unit
HUT-2

Pipe straps

Name of manufacturer : SHOWA

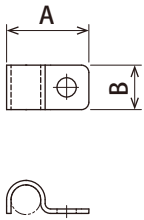
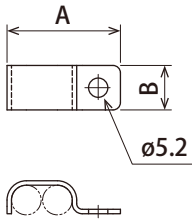
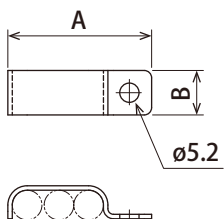
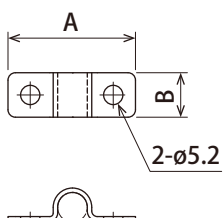
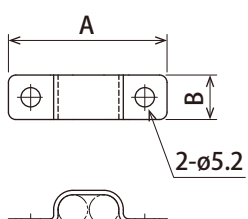
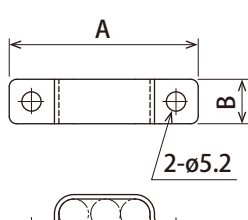
N a m e	Configuration	M o d e l	Applicable pipe O.D. (mm)	A(mm)	B(mm)	Mass(kg)	Model of manufacturer
Pipe strap Single-sided type Single		ZH-9A2552-032	ø8	22.2	12	0.003	PZ0108
		ZH-9A2552-052	ø12	26.4	16	0.007	PZ0112
Pipe strap Single-sided type Double		ZH-9A2552-082	ø8	30.6	12	0.004	PZ0208
		ZH-9A2552-102	ø12	38.8	16	0.009	PZ0212
Pipe strap Single-sided type Triple		ZH-9A2552-132	ø8	38.8	12	0.005	PZ0308
		ZH-9A2552-152	ø12	51	16	0.011	PZ0312
Pipe strap Double-sided type Single		ZH-9A2552-031	ø8	34	12	0.004	PZ1108
		ZH-9A2552-051	ø12	38	16	0.008	PZ1112
Pipe strap Double-sided type Double		ZH-9A2552-081	ø8	42.4	12	0.005	PZ1208
		ZH-9A2552-101	ø12	50.4	16	0.01	PZ1212
Pipe strap Double-sided type Triple		ZH-9A2552-131	ø8	50.6	12	0.006	PZ1308
		ZH-9A2552-151	ø12	62.6	16	0.013	PZ1312

Mounting screws are not included. M5x10 Washer assembled cross recessed pan head screws P=4 (model 8BC510P3U0) needs to be ordered separately.

Pipe straps with base

Name of manufacturer : SOUGOKOUGYOU

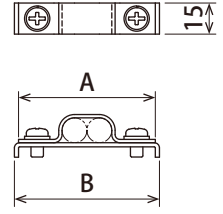
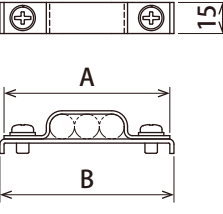
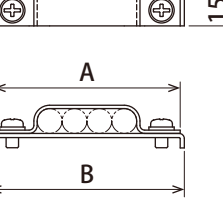
N a m e	Configuration	M o d e l	Applicable pipe O.D. (mm)	A(mm)	B(mm)	Mass(kg)	Model of manufacturer
Pipe strap with base Double		ZH-9A2575-080	ø8	58	62	0.037	8x2W, Z-9
		ZH-9A2575-200	ø12	66	70	0.041	12x2W, Z-3
Pipe strap with base Triple		ZH-9A2575-090	ø8	66	70	0.04	8x3W, Z-3
		ZH-9A2575-210	ø12	80	84	0.047	12x3W, Z-5
Pipe strap with base Quadruple		ZH-9A2575-100	ø8	74	78	0.043	8x4W, Z-4
		ZH-9A2575-220	ø12	90	94	0.052	12x4W, Z-6